

Modbus Server

BACnet MSTP and BACnet/IP client

USER MANUAL

Issue date: 03/2020 r1.3 ENGLISH

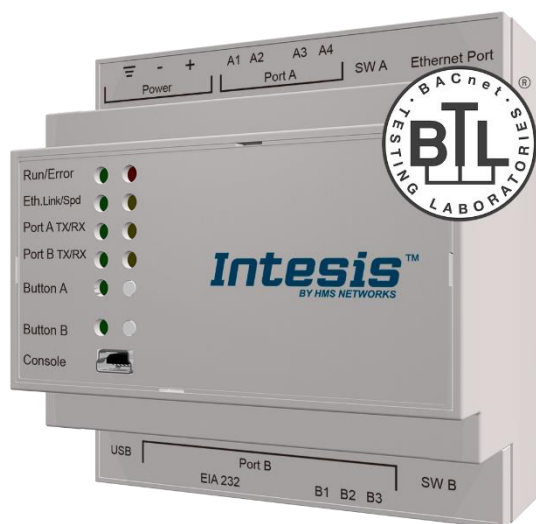

Important User Information

Disclaimer

The information in this document is for informational purposes only. Please inform HMS Industrial Networks of any inaccuracies or omissions found in this document. HMS Industrial Networks disclaims any responsibility or liability for any errors that may appear in this document.

HMS Industrial Networks reserves the right to modify its products in line with its policy of continuous product development. The information in this document shall therefore not be construed as a commitment on the part of HMS Industrial Networks and is subject to change without notice. HMS Industrial Networks makes no commitment to update or keep current the information in this document.

The data, examples and illustrations found in this document are included for illustrative purposes and are only intended to help improve understanding of the functionality and handling of the product. In view of the wide range of possible applications of the product, and because of the many variables and requirements associated with any particular implementation, HMS Industrial Networks cannot assume responsibility or liability for actual use based on the data, examples or illustrations included in this document nor for any damages incurred during installation of the product. Those responsible for the use of the product must acquire sufficient knowledge in order to ensure that the product is used correctly in their specific application and that the application meets all performance and safety requirements including any applicable laws, regulations, codes and standards. Further, HMS Industrial Networks will under no circumstances assume liability or responsibility for any problems that may arise as a result from the use of undocumented features or functional side effects found outside the documented scope of the product. The effects caused by any direct or indirect use of such aspects of the product are undefined and may include e.g. compatibility issues and stability issues.

Gateway for the integration of BACnet MSTP and BACnet IP installations into Modbus RTU or Modbus TCP enabled monitoring and control systems.

ORDER CODE	LEGACY ORDER CODE
INMBSBAC1000000	IBMBSBAC1000000
INMBSBAC2500000	IBMBSBAC2500000
INMBSBAC6000000	IBMBSBAC6000000
INMBSBAC1K20000	IBMBSBAC1K20000
INMBSBAC3K00000	IBMBSBAC3K00000

INDEX

Description5

 1.1 Introduction5

 1.2 Functionality6

 1.3 Gateway's capacity6

2 BACnet interface7

 2.1 Description7

 2.2 BACnet/IP8

 2.3 BACnet MSTP8

 2.4 Points definition9

3 Modbus interface9

 3.1 Description9

 3.2 Functions supported9

 3.3 Modbus RTU10

 3.4 Modbus TCP10

 3.5 Address Map10

 3.6 Points definition10

4 Connections12

 4.1 Powering the device13

 4.2 Connection to Modbus13

 4.2.1 Modbus TCP13

 4.2.2 Modbus RTU13

 4.3 Connection to BACnet13

 4.3.1 BACnet IP13

 4.3.2 BACnet MSTP14

 4.4 Connection to the configuration tool14

5 Set-up process and troubleshooting15

 5.1 Pre-requisites15

 5.2 Intesis MAPS. Configuration & monitoring tool for Intesis BACnet series15

 5.2.1 Introduction15

 5.2.2 Connection15

 5.2.3 Configuration tab16

 5.2.4 Signals22

 5.2.5 Sending the configuration to Intesis23

 5.2.6 Diagnostic23

 5.3 Set-up procedure25

6 Electrical & Mechanical Features26

7 Dimensions27

Description

1.1 Introduction

This document describes the integration of BACnet MSTP and BACnet IP installations into Modbus RTU or Modbus TCP compatible devices and systems using the Intesis *Modbus Server – BACnet Client* gateway.

The aim of this integration is to make accessible BACnet system signals and resources from a Modbus based control system or device, as if it was a part of the own Modbus system and vice-versa.

The gateway acts as a Modbus TCP Server or Modbus RTU slave device in its Modbus interface, allowing a Modbus master/client device to read/write to its internal points. From BACnet point of view, Intesis acts as a BACnet client device, able to subscribe (COV) or do periodic polling of configured BACnet points.

Configuration is carried out using the configuration software Intesis™ MAPS.

This document assumes that the user is familiar with Modbus and BACnet technologies and their technical terms.

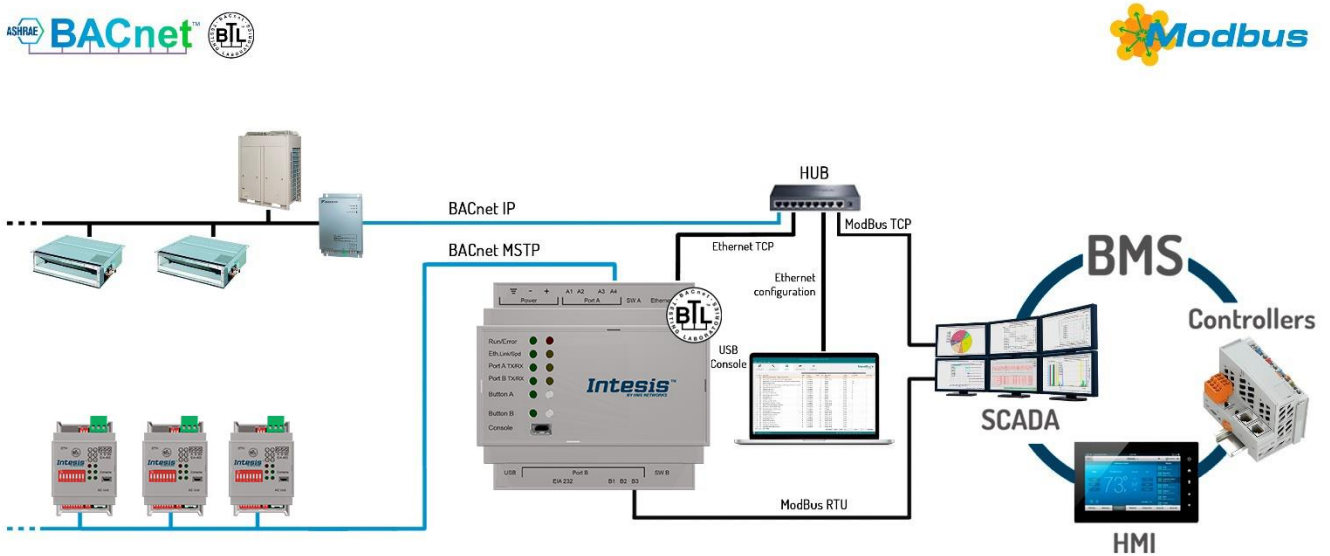

Integration of BACnet IP or BACnet MSTP server systems into Modbus TCP or Modbus RTU control and monitoring systems

1.2 Functionality

From the BACnet system point of view, after the start up process, Intesis subscribes to configured BACnet points or reads them continuously from their respective BACnet server devices and updates in its memory the value of the present_value property received from them.

From the Modbus system point of view, after the start up process, the gateway presents its points as Modbus Registers, to be read or written by a Modbus client/master device using standard Modbus functions. The values received from Modbus are immediately written in the associated present_value property of the corresponding object.

Each BACnet object from the BACnet server devices is associated to a *Modbus register*, with this, all the configured points of the BACnet server devices are seen as a *single Modbus server with many registers* from the Modbus system point of view, each register corresponding to a present_value of an object on a particular BACnet server device.

When a new value is read from BACnet for a given object/present_value, the new value is updated in the gateway's memory and made accessible at Modbus Server interface.

In the continuous polling of the BACnet server, if an unresponsive BACnet server device is detected, the corresponding virtual signal inside Intesis will be activated indicating communication error with the BACnet server device. These virtual signals indicating communication status in real time with the BACnet devices are also accessible from Modbus, like the rest of the points of the gateway.

1.3 Gateway's capacity

Intesis capacity is listed below:

Element	100 version	250 version	600 version	1200 version	3000 version	Notes
Type of BACnet devices	IP / MSTP					Communication with BACnet IP and MSTP
Number of BACnet devices	256					Maximum number of different BACnet devices the Intesis can communicate to
Number of Modbus Registers	100	250	600	1200	3000	Maximum number of points that can be defined in the virtual Modbus Server device inside the gateway
Modbus link layers supported	Modbus RTU (EIA485) Modbus TCP					Those supporting Modbus protocol. Communication over TCP/IP and RTU

2 BACnet interface

This section describes the BACnet part of the Intesis's configuration and functionality.

2.1 Description

BACnet server devices are represented in the form of *Devices* holding *Objects*, normally every physical device corresponds to a logical one. The *Objects* can be of different type depending on the data and functionality they represent: Analog Input, Analog output, Digital Input, etc. Up to 23 different types of objects. Note that Outputs are objects meant to be written in the direction BACnet network to the device, and the opposite for Inputs (they are meant to offer status information of the BACnet device). Value objects are bidirectional.

Every *Object* has different properties. The most meaningful one, and the one used to read and write values by Intesis is the *Present Value* property, which indicates the real value of the object. Every Object of the same type in a *Device* is identified with its associated *Object Instance*.

These are the possible BACnet objects supported by Intesis:

Object Type	Property	Description
Analog Input	Present Value	Analog signal. i.e. Ambient temperature.
Analog Output	Present Value	Analog signal.
Analog Value	Present Value	Analog signal. i.e. Temperature set point value.
Binary Input	Present Value	Digital signal. i.e. ON/OFF status.
Binary Output	Present Value	Digital signal. i.e. ON/OFF command.
Binary Value	Present Value	Digital signal. i.e. ON/OFF status/command.
Multistate Input	Present Value	Multistate signal. i.e. Working mode status.
Multistate Output	Present Value	Multistate signal.
Multistate Value	Present Value	Multistate signal. i.e. Working mode command.
Accumulator	Present Value	
Loop	Present Value	

Every signal is identified with its associated *Device + Object Type + Object Instance*.

Intesis simulates a virtual BACnet device inside the BACnet system acting as client device in the BACnet system. The communication with the rest of the BACnet devices is done via the Ethernet port of the gateway which implements the BACnet protocol.

Intesis implements a single BACnet object of its own: this is, its BACnet Device Object, containing its BACnet Device Identifier and basic properties of Intesis as BACnet device (name, firmware version, etc).

Using the configuration tool with Intesis it's possible to scan the BACnet network for available devices and their objects, which can later be directly added to your configuration. This facilitates the configuration process, avoiding to enter them manually.

BACnet/IP and BACnet MSTP physical layers are supported. Only one physical layer can be used at a time. This is, if communicating to BACnet using BACnet/IP, BACnet MSTP cannot be used, and viceversa.

2.2 BACnet/IP

Main parameter to set up for BACnet/IP, additional to basic IP settings (IP, netmask, default gateway) is the communication port. Intesis uses port 47808 (0xBAC0) by default and it can be changed at configuration time.

When using BACnet/IP, device can also act as a Foreign Device (in order to be able to communicate with devices that are in another network domain), alternatively implement a BBMD itself (Bacnet/IP Broadcast Management Device). This functionality facilitates communication of devices in other networks with the devices in the network where Intesis is installed.

Communication with BACnet/IP excludes possibility of communicating with BACnet MSTP from Intesis.

2.3 BACnet MSTP

When choosing BACnet MSTP device needs to be associated with a MAC address (address within the MSTP network segment), to be configured with configuration software.

Following baud rates are supported for MSTP line: 9600, 19200, 38400, 76800, 115200 or Autobauding (autodetect).

Standard wiring guidelines for EIA485 apply for the BACnet MSTP line.

Communication with BACnet MSTP excludes possibility of communicating with BACnet/IP from Intesis.

2.4 Points definition

Every point defined in Intesis has the following BACnet features associated to it:

Feature	Description
BACnet Device	<p>BACnet device to which belongs the point, from a list of BACnet devices that can be defined in Intesis (up to 16).</p> <p>For every BACnet device defined, a virtual signal is created automatically in Intesis to inform about the communication with the BACnet device, this signal is available also from the Modbus interface like the rest of points.</p>
BACnet object type	<p>BACnet object type for the point. It can be one of the following BACnet object types supported by Intesis:</p> <p>AI = Analog Input. AO = Analog Output. AV = Analog Value. DI = Digital Input. DO = Digital Output. DV = Digital Value. MI = Multistate Input. MO = Multistate Output. MV = Multistate Value. LOOP = Loop ACUM = Accumulator</p> <p><i>Consult documentation of BACnet device(s) to integrate for information about BACnet object types of the points desired to integrate.</i></p>
BACnet object instance	<p>BACnet object instance for the point on the external BACnet device.</p> <p><i>Consult documentation of BACnet device(s) to integrate for information about BACnet object instance of the points desired to integrate.</i></p>

Note that configuration tool used with Intesis enables for discovery of existing BACnet devices in the network, as well as their BACnet objects and types, which can be later directly added in configuration. This facilitates the process of choosing suitable parameters above for every BACnet object on every BACnet device to integrate.

3 Modbus interface

3.1 Description

Intesis acts as a slave device in its Modbus interface, this interface can be the Ethernet port (if using Modbus TCP), or the EIA232/EIA485 ports (if using Modbus RTU). To access the points and resources of the Intesis from a Modbus master device, you must specify as Modbus register addresses, those configured inside Intesis corresponding to BACnet signals. See details below in this document.

The Intesis can have Modbus RTU mode active, Modbus TCP mode active, or both modes active at the same time.

3.2 Functions supported

This part is common for Modbus TCP & RTU.

Modbus functions 01 and 02 (*coils and digital input registers*) can be used to read Modbus registers.

Modbus functions 03 and 04 (*read holding registers* and *read input registers*) can be used to read Modbus registers.

Modbus functions 05 and 15 (*Single digital Holding Registers* and *Write Multiple Holding Registers*) can be used to write Modbus registers.

Modbus functions 06 and 16 (*Single Multiple Holding Registers* and *Write Multiple Holding Registers*) can be used to write Modbus registers.

If *poll records* are used to read or write more than one register, it is necessary that the range of addresses requested contains valid addresses; if not the corresponding Modbus error code will be returned.

All the registers are of 2 bytes, even if they are associated to signals of type bit in the external system, and its content is expressed in MSB..LSB.

Modbus error codes are fully supported; they will be sent whenever a non-valid Modbus action or address is required.

3.3 Modbus RTU

Baud rate can be selected from 1200, 2400, 4800, 9600, 19200, 38400, 56700 and 115200.

Data Bits:8

Parity can be selected from: none, even, odd.

Stop Bits:1 and 2.

Modbus slave number can be configured. Physical connection (EIA232 or EIA485) can also be selected.

Only the lines RX, TX and GND of the EIA232 connector are used (TX/RX+ and TX/RX- for EIA485).

3.4 Modbus TCP

The TCP port to use can be configured (by default 502 is used).

The IP address, subnet mask and default router address to use by Intesis can be also configured.

3.5 Address Map

The Modbus address map is fully configurable; any point in the Intesis can be freely configured with the desired Modbus register address.

3.6 Points definition

Every point defined in the gateway has the Modbus *Format*, *Point* and *R/W* features associated to it that can be configured. These features are explained in section 5.2.4.

Each point defined in Intesis has the following Modbus features associated to it:

Feature	Description
#Bits	<p>One of the following bit lengths can be used:</p> <ul style="list-style-type: none"> • 1 bit • 16 bits • 32 bits
Data Coding Format	<p>One of the following Modbus data coding formats can be used:</p> <ul style="list-style-type: none"> • 16/32 unsigned. • 16/32 bits signed (one's complement – C1). • 16/32 bits signed (two's complement – C2).

	<ul style="list-style-type: none"> • 16/32 bits Float. • 16/ bits Bitfields. • Error comm
Function code	<p>One of the following Modbus function codes can be used:</p> <ul style="list-style-type: none"> • 1- Read Coils. • 2- Read Discrete Inputs. • 3- Read Holding Registers. • 4- Read Input Registers. • 5- Write Single Coil. • 6- Write Single Register. • 15- Write Multiple Coils. • 16- Write Multiple Registers.
Byte Order	<ul style="list-style-type: none"> • Big Endian • Little Endian • Word Inverted Big Endian • Word Inverted Little Endian
Register Address	The Modbus register address inside the slave device for the point.
Bit inside the register	<p>Bit inside the Modbus register (optional). The gateway allows bit decoding from generic 16 bits input/holding Modbus registers.</p> <p><i>Bit coding into 16 bits input/holding Modbus registers is used for some devices to encode digital values into this type of registers, being these registers normally accessible using Modbus function codes 3 and 4 (read holding/input registers).</i></p>
Read/Write	<p>0: Read 1: Write 2: Read / Write</p>

4 Connections

Find below information regarding the Intesis connections available.

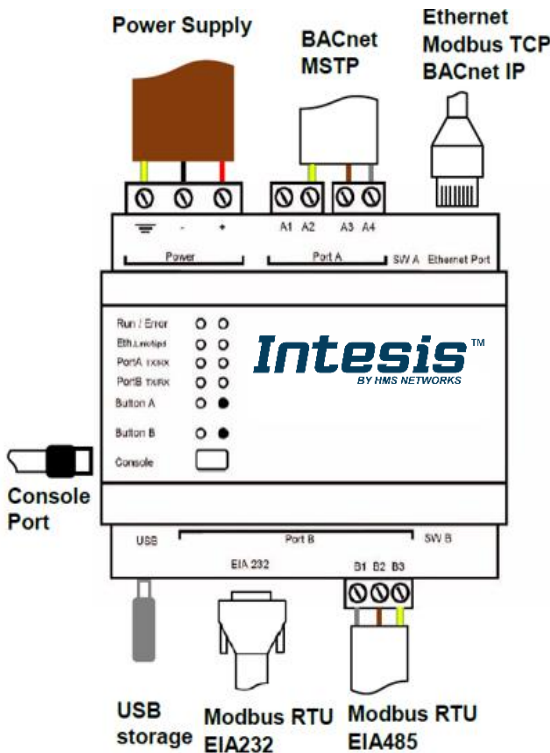

Power Supply

Must use NEC Class 2 or Limited Power Source (LPS) and SELV rated power supply.

If using DC power supply:

Respect polarity applied of terminals (+) and (-). Be sure the voltage applied is within the range admitted (check table below). The power supply can be connected to earth but only through the negative terminal, never through the positive terminal.

If using AC power supply:

Make sure the voltage applied is of the value admitted (24 Vac). Do not connect any of the terminals of the AC power supply to earth, and make sure the same power supply is not supplying any other device.

Ethernet / BACnet IP / Modbus TCP

Connect the cable coming from the IP network to the connector ETH of the gateway. Use an Ethernet CAT5 cable. If communicating through the LAN of the building, contact the network administrator and make sure traffic on the port used is allowed through all the LAN path (check the gateway user manual for more information). With factory settings, after powering up the gateway, DHCP will be enabled for 30 seconds. After that time, if no IP is provided by a DHCP server, the default IP 192.168.100.246 will be set.

PortA / BACnet MSTP

Connect the EIA485 bus to connectors A3 (A-), A4 (B+) and A1 or A2 (SNGD) of gateway's PortA. Respect the polarity.

PortB / Modbus RTU

Connect the EIA485 bus to connectors B1 (B+), B2 (A-) and B3 (SNGD) of gateway's PortB. Respect the polarity.

Note for PortA and PortB; Remember the characteristics of the standard EIA485 bus: maximum distance of 1200 meters, maximum 32 devices connected to the bus, and in each end of the bus it must be a termination resistor of 120 Ω. The port includes a DIP-Switch for configuration of biasing circuit as well as termination:

SW1:

- ON:** 120 Ω termination active
- OFF:** 120 Ω termination inactive (default)

SW2-3:

- ON:** Polarization active (default in BACnet MSTP port)
- OFF:** Polarization inactive (default in Modbus RTU port)

If the gateway is installed in one bus end make sure that termination is active.

Console Port

Connect a mini-type B USB cable from your computer to the gateway to allow communication between the Configuration Software and the gateway. Remember that Ethernet connection is also allowed. Check the user manual for more information.

USB

Connect a USB storage device (not a HDD) if required. Check the user manual for more information.

Ensure proper space for all connectors when mounted (see section 7).

4.1 Powering the device

A power supply working with any of the voltage range allowed is needed (check section 6). Once connected the RUN led (Figure above) will turn on.

WARNING! In order to avoid earth loops that can damage the gateway and/or any other equipment connected to it, we strongly recommend:

- The use of DC power supplies, floating or with the negative terminal connected to earth. **Never use a DC power supply with the positive terminal connected to earth.**
- The use of AC power supplies only if they are floating and not powering any other device.

4.2 Connection to Modbus

4.2.1 Modbus TCP

Connect the communication cable coming from the network hub or switch to the ETH port of Intesis. The cable to be used shall be a straight Ethernet UTP/FTP CAT5 cable.

4.2.2 Modbus RTU

Connect the communication cable coming from the Modbus network to the port marked as Modbus of Intesis. Connect the EIA485 bus to connectors to connectors B1 (B+), B2 (A-) and B3 (SNGD) of gateway's PortB. Respect the polarity.

Remember the characteristics of the standard EIA485 bus: maximum distance of 1200 meters, maximum 32 devices connected to the bus, and in each end of the bus it must be a termination resistor of 120 Ω . Set port switch SW1 to ON if gateway is installed on one bus end. SW2-3 will generally go OFF (no polarization), as polarization will typically be provided in the Modbus RTU master device.

4.3 Connection to BACnet

4.3.1 BACnet IP

Connect the communication cable coming from the network hub or switch to the ETH port (Figure above) of Intesis. The cable to be used shall be a straight Ethernet UTP/FTP CAT5 cable

In case there is no response from the BACnet devices to the frames sent by Intesis, check that they are operative and reachable from the network connection used by Intesis. Check the Intesis Ethernet interface sending *Pings* to its IP address using a PC connected to the same Ethernet network.

Check as well with the network admin that there are no limitations regarding UDP communication or ports blocked.

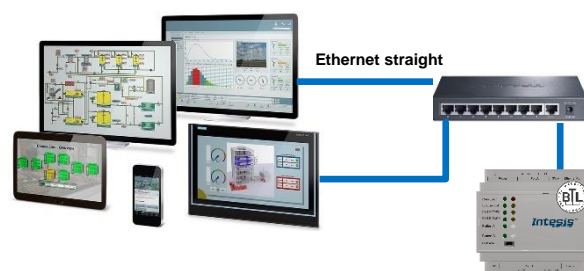

BACnet IP connection using switch/hub and straight cable

4.3.2 BACnet MSTP

Connect the EIA485 bus to connectors A3 (A-), A4 (B+) and A1 or A2 (SNGD) of gateway's PortA. Respect the polarity.

Remember the characteristics of the standard EIA485 bus: maximum distance of 1200 meters, maximum 32 devices connected to the bus, and in each end of the bus it must be a termination resistor of 120 Ω . Set port switch SW1 to ON if gateway is installed on one bus end. SW2-3 will generally go to ON (polarization active), unless there is another client / header device providing polarization in the same bus.

4.4 Connection to the configuration tool

This action allows the user to have access to configuration and monitoring of the device (more information can be found in the configuration tool User Manual). Two methods to connect to the PC can be used:

- **Ethernet:** Using the Ethernet port of Intesis.
- **USB:** Using the console port of Intesis, connect a USB cable from the console port to the PC.

5 Set-up process and troubleshooting

5.1 Pre-requisites

It is necessary to have a Modbus TCP client or Modbus RTU master operative and well connected to the corresponding Modbus port of Intesis as well as the BACnet IP or BACnet MSTP server devices connected to their corresponding ports as well.

Connectors, connection cables, PC to use the configuration tool and other auxiliary material, if needed, are not supplied by HMS Industrial Networks S.L.U for this standard integration.

Items supplied by HMS Networks for this integration are:

- Intesis gateway.
- Mini-USB cable to connect to PC
- Link to download the configuration tool.
- Product documentation.

5.2 Intesis MAPS. Configuration & monitoring tool for Intesis BACnet series

5.2.1 Introduction

Intesis MAPS is a Windows® compatible software developed specifically to monitor and configure Intesis Modbus series.

The installation procedure and main functions are explained in the *Intesis MAPS User Manual for Modbus*. This document can be downloaded from the link indicated in the installation sheet supplied with the Intesis device or in the product website at www.intesis.com

In this section, only the specific case of BACnet to Modbus systems will be covered.

Please check the Intesis MAPS user manual for specific information about the different parameters and how to configure them.

5.2.2 Connection

To configure the Intesis connection parameters press on the **Connection** button in the *menu bar*.

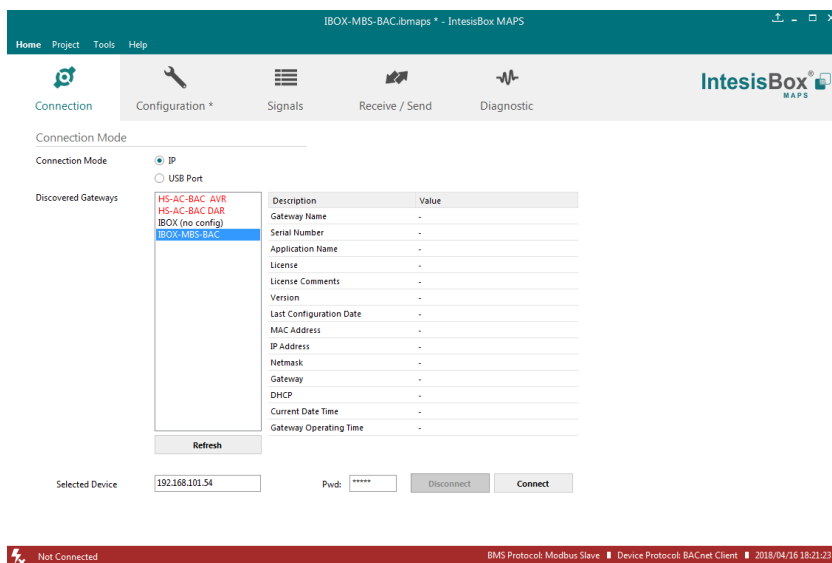

Figure 5.1 MAPS connection

5.2.3 Configuration tab

Select the **Configuration** tab to configure the connection parameters. Three subsets of information are shown in this window: General (Gateway general parameters), Modbus Slave (Modbus interface configuration) and BACnet Client (BACnet interface parameters).

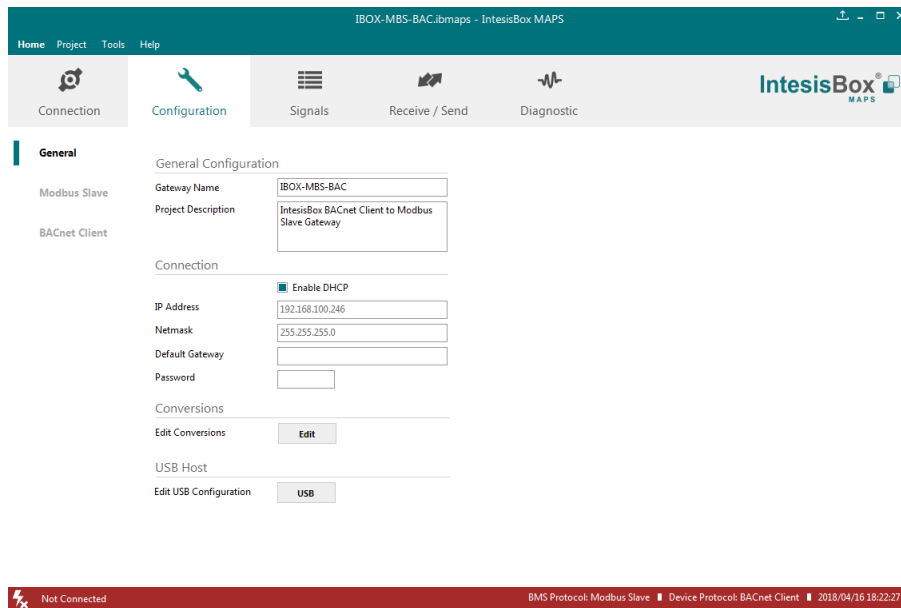

Figure 5.2 Intesis MAPS configuration tab

General and Modbus Slave tabs are explained in Intesis MAPS user manual for Intesis Modbus Server Series.

5.2.3.1 BACnet Client Configuration

Set the parameters for connection to BACnet network / BACnet server devices in the network.

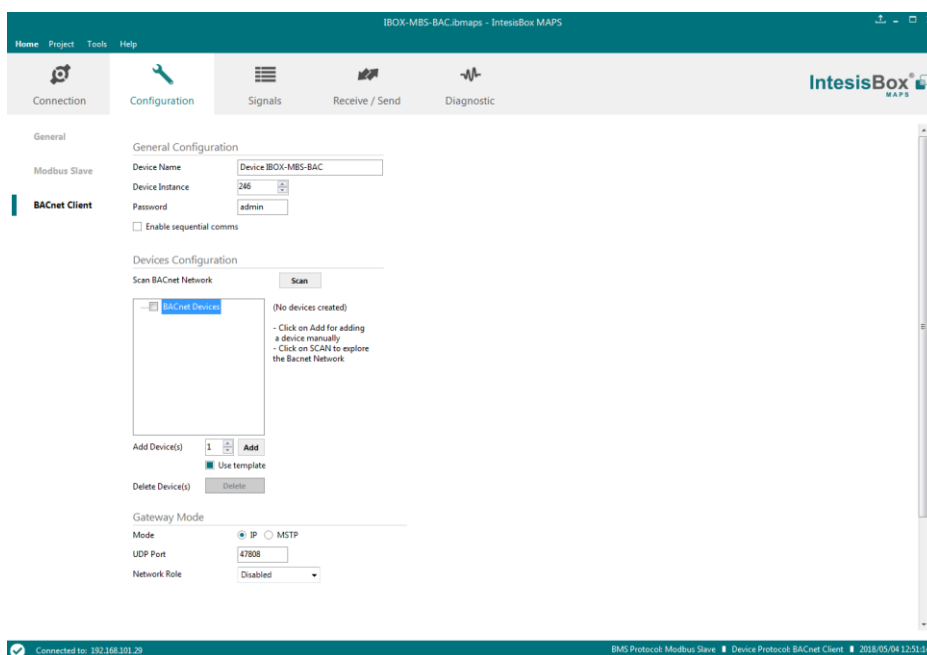

Figure 5.3 Intesis MAPS configuration tab for BACnet Client

Configuration for BACnet client has three sections: General Configuration, Devices Configuration and Gateway Mode.

- General Configuration

In this section, following parameters should be configured:

1. **Device Name.** Name of the device in the bacnet network ('object name' property of device object)
2. **Device Instance.** Instance number of the device in the bacnet network (instance number property of device object)
3. **Password.** BACnet password of the device to execute service 'Device Management – Restart', sent by other device in the BACnet network.
4. **Sequential comms.** Enables sequential communication with other BACnet server devices. This is, no new request will be initiated from Intesis until response to last request has been received. This becomes necessary in case of communication with BACnet MSTP devices behind a BACnet IP to MSTP router, as no concurrent transactions are possible in MSTP.

- Gateway Mode

In this section, following parameters should be configured:

1. **Mode.** Select whether Intesis is going to connect with BACnet IP or BACnet MSTP. Rest of parameters in the section will be different depending on this.
2. **(Mode IP) UDP Port.** UDP port that will be used for BACnet IP communication. It defaults to 47808 (0xBAC0)
3. **(Mode IP) Network Role.** Related to capability of the device of communicating with devices from other networks. Disabled, Foreign Device or BBMD are the possible choices. In case of Foreign Device, IP of the BBMD where it will connect needs to be entered, as well as TTL (time-to-live). In case of selecting BBMD, table of BBMD's in the BACnet network needs to be entered.
4. **(Mode MSTP) Max Masters.** Highest MAC address of BACnet MSTP master device in the MSTP line.
5. **(Mode MSTP) Max Info Frames.** Max number of frames that the device can send out to the network when it receives token in the MSTP line.
6. **(Mode MSTP) Baudrate.** Baudrate of the BACnet MSTP link.
7. **(Mode MSTP) MAC Address.** MAC address of Intesis as BACnet MSTP device in the MSTP line.

- Devices Configuration

In this section, a single entry for which BACnet server device the Intesis is to communicate with needs to be entered.

In Signals table, each signal will need to be associated with the device it will be read to/written from.

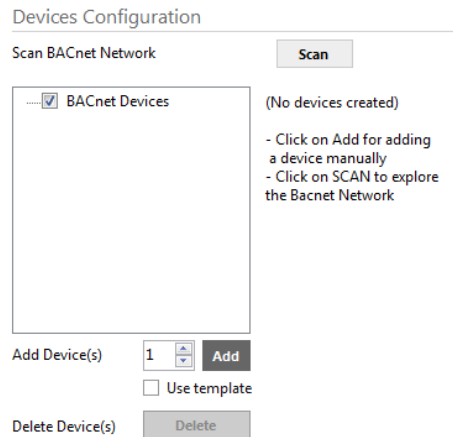

Figure 5.4 Devices configuration section

Devices can be added in three ways:

- **Manually:** With checkbox 'Use template' disabled, **Add** button should be clicked. Number of devices to add can be adjusted in the text field next to button **Add**.
- **From template:** Same as manual but based on a template file. This will add in Signals table all the signals specified in the template file for the device to be integrated.
- **From scan:** Gives functionality to scan the BACnet network for existing BACnet server devices and their objects, enabling to add them in the config. See section 'BACnet scan functionality' below for further detail.

Once a device is added, following fields must be filled in for each device:

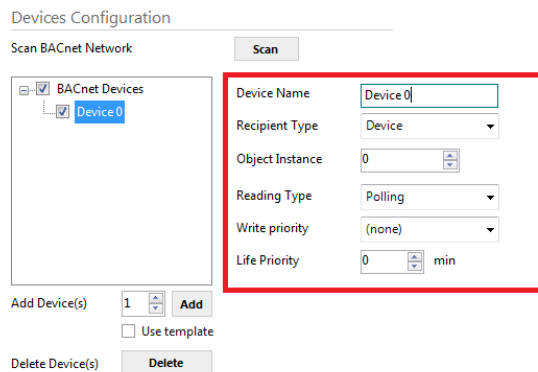

Figure 5.5 Devices configuration section

1. **Device Name.** Device identifier within MAPS. It will be used to reference the device from the signals table
2. **Recipient Type.** Way in which the device will be identified within the BACnet network. Options are Device (instance), Address, Address (MSTP). Depending on which option is chosen different parameters will appear to enter the details of the address.
3. **(Recipient type: Device) Object Instance:** Instance number of device object for the BACnet server device.
4. **(Recipient type: Address) Network:** Destination network, 0..65535. 0 for local network, 65535 for broadcast (all networks).
5. **(Recipient type: Address) IP / Port:** IP and Port of the BACnet server device.

- 6. **(Recipient type: Address (MAC)) Network:** Destination network, 0..65535. 0 for local network, 65535 for broadcast (all networks).
 - 7. **(Recipient type: Address (MAC)) MSTP MAC Address:** MAC address 0..255 of the BACnet server device.
 - 8. **Reading type:** Related to service that will be used to read the BACnet server device. Options are Polling (ReadProperty), COV, COV-unconf (unconfirmed COV), Polling Multiple (ReadPropertyMultiple).
 - 9. **Write priority:** priority with which writes will be performed. Default is (none) (no priority), can be chosen from 1 (highest) to 16 (lowest) and none.
 - 10. **COV Lifetime:** Periodic timeout at which COV subscription will be renewed.
- BACnet scan functionality

Devices Configuration section includes functionality to scan the BACnet network for existing BACnet servers and their objects.

To access this Scan functionality window, make sure that you're online/connected with the device and click on **Scan** button.

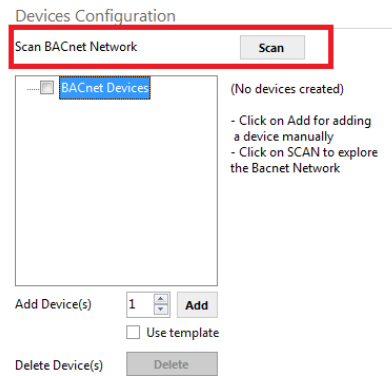

Figure 5.6 BACnet Network scan button

If properly connected to the Intesis, following dialog will appear:

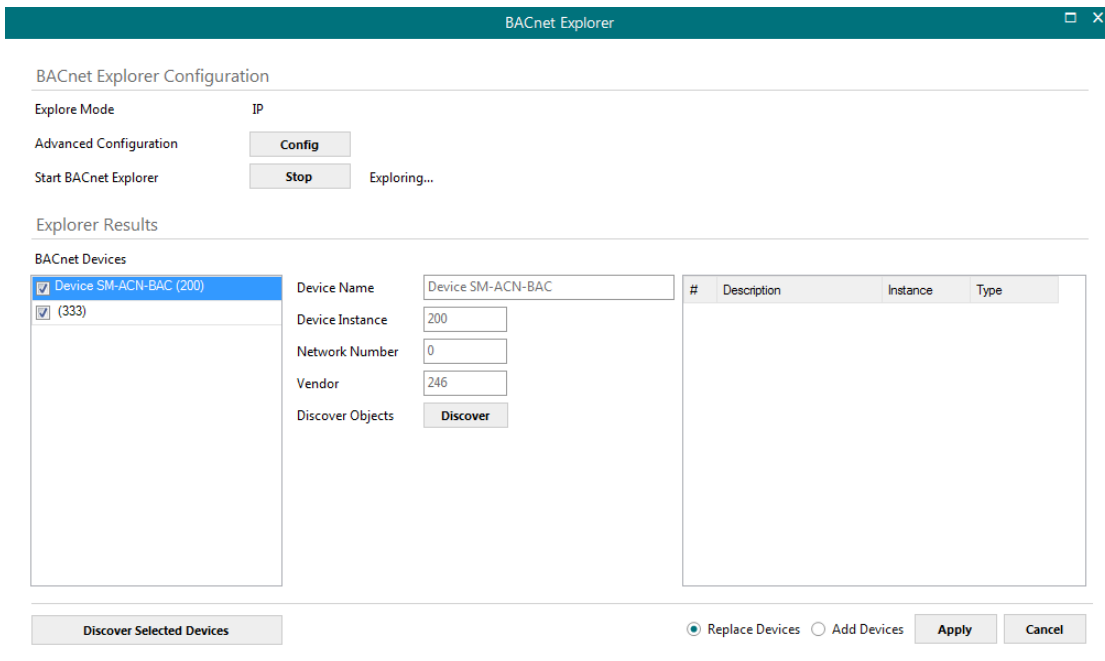



Figure 5.7 BACnet Network scan dialog

In top section of the window **BACnet Explorer Configuration**, following parameters are available:

- **Explore Mode:** It can be either IP or MSTP, depending on last configuration downloaded to Intesis.



NOTE: Bacnet Explorer function will use or BACnet exploration actual parameters for BACnet configured in Intesis. This is, values for Link layer (IP or MSTP), Device Object Instance, MAC & baud rate or IP address, etc.
Therefore, it might be necessary to download a basic BACnet configuration parameters to the Intesis before proceeding with the scan of the BACnet network

- **Advanced Configuration:** In this section the way the scan is performed is configured. Following parameters can be setup:
 1. **Start and End Instance:** Search will be based on Device object instance number of present devices in the network. Search can be done on all possible Instances (0 to 4194302) or narrowed down (until even a single device) if the Device instance is known a priori, or within a certain range. Narrowing the value between start and end instance will speed up the search for BACnet devices
 2. **Step:** Number of BACnet devices queried at once.
 3. **Scan timeout:** Timeout that will wait for answer after request from a BACnet device.
 4. **Discover MSTP slaves** (only when Explore Mode is MSTP): Will enable scan of MSTP slave nodes (by default, only MSTP master nodes will be discovered). If enabled, **Start MAC**, **End MAC** and **Timeout** (in ms) for the scan can be adjusted.
 5. **MSTP Slaves through IP** (only when Explore Mode is IP): In case that BACnet IP to MSTP routers are present in the BACnet/IP network, will enable scan of MSTP slaves through the corresponding BACnet/IP router (note that MSTP master nodes under a BACnet/IP router will always be scanned). If enabled, **Net Number**, **Start MAC**, **End MAC** and **Timeout** (in ms) for the scan can be adjusted.
- **Start BACnet Explorer:** Exploration of the bacnet network will start once the window **BACnet Explorer** itself is open. You can Stop and restart it (button **Stop** becomes **Start**), in order to stop scanning traffic in the BACnet network. BACnet devices found in the network will appear in **Explorer Results** section as they respond.

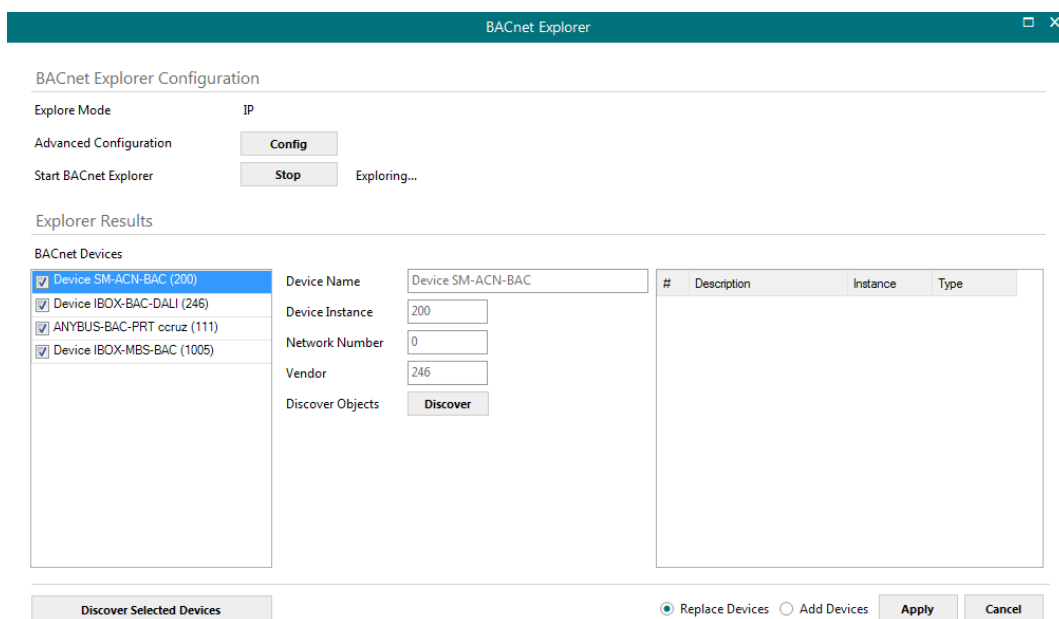

Figure 5.8 BACnet Explorer sample results on scan dialog

By clicking each of the devices, its Device Name, Instance, Network Number and Vendor Id will be given in the center of the dialog.

Once list of devices is shown, next step is obtaining their list of objects. This can be done in two ways:

- Selecting a particular device and clicking at **Discover** button
- Checking all devices whose objects are to be scanned and clicking at **Discover Checked Devices** button. This must be used with care when many devices are checked at once. Resulting scan time can become very large.

Either way, when having discovered objects under a BACnet device, they are shown in the list at the right part of the window:

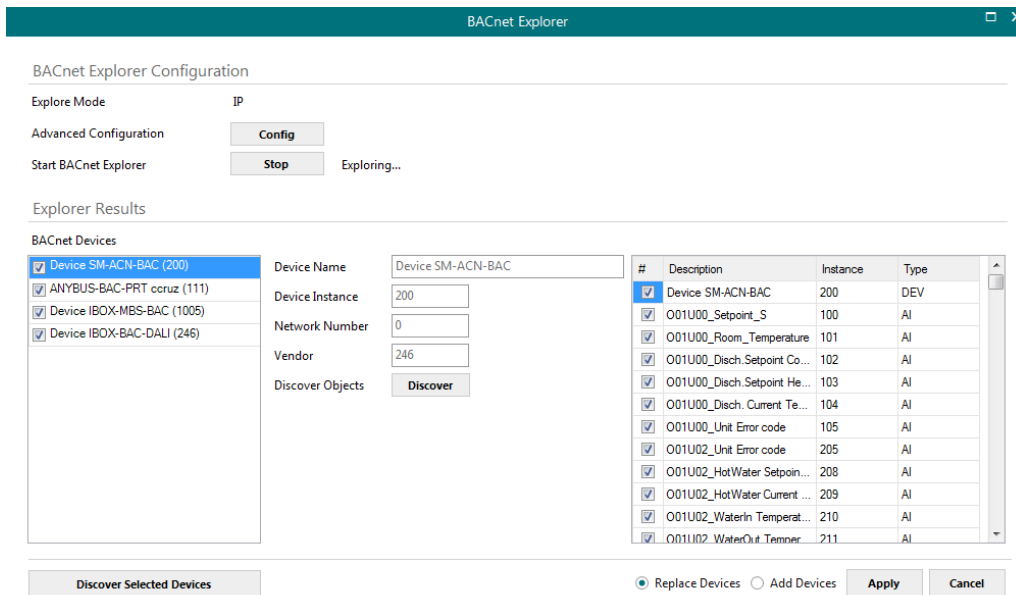

Figure 5.9 BACnet Explorer showing objects found under a BACnet device

After objects have been discovered, it must be selected both the BACnet devices to be integrated, as well as the signals of each that are desired in the project.

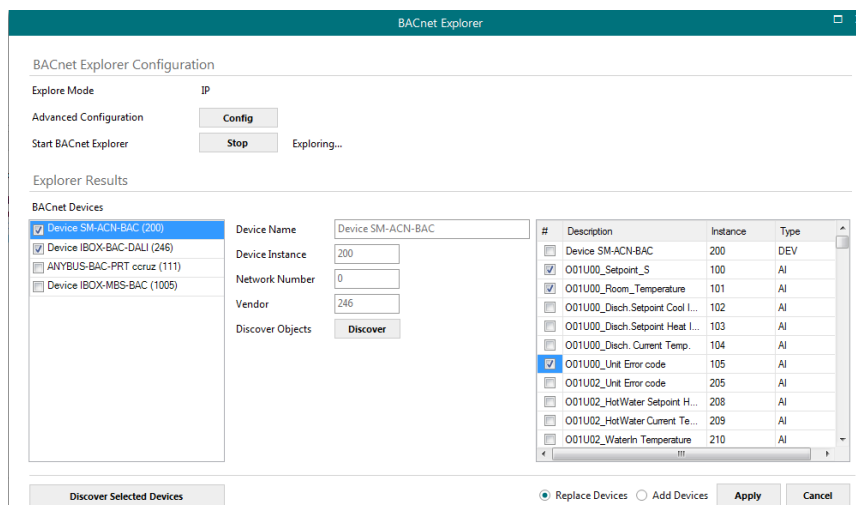

Figure 5.10 BACnet Explorer with a selection of objects and devices to integrate

In the example above, if Apply button is pressed, two devices will be integrated:

- Device INBACSAM---0000 (200)
- Device INBACDAL---0000(246)

The BACnet objects that will be integrated in configuration are *O01U00_Setpoint_S* and *O01U00_Room_Temperature* for Device *INBACSAM---0000*, and those selected for Device *INBACDAL---0000*(can be seen when device is selected in the list at the left part of the window).

Next step is to transfer those objects to MAPS configuration. To do so, it must be first selected if those selected objects are meant to replace the entire configuration (**Replace Devices** – default) or added to existing signals configuration (**Add Devices**).

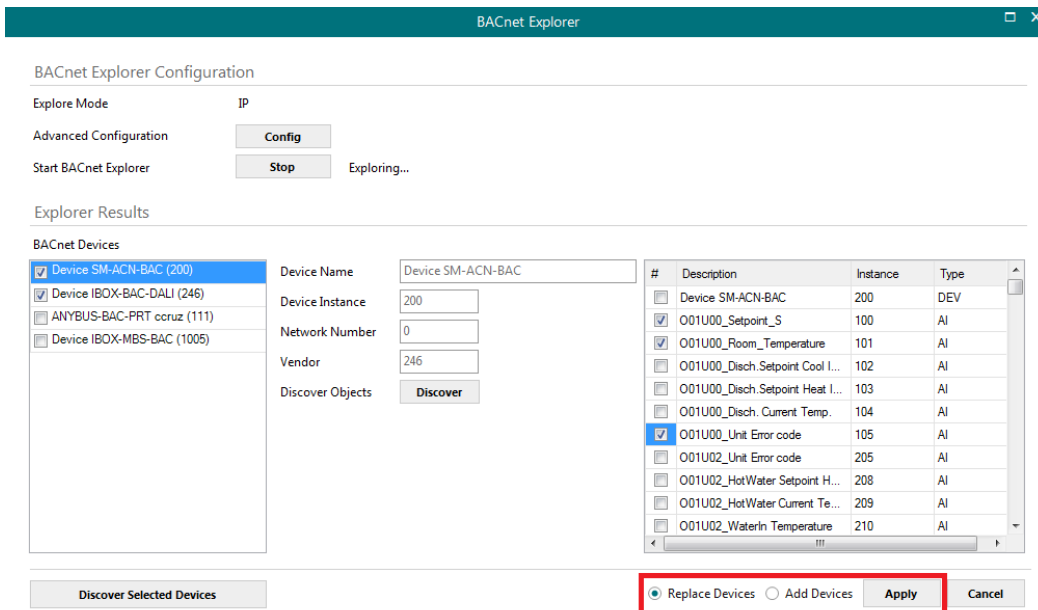

Figure 5.11 Apply button and selection on whether Replace or Add Devices

Apply button must be pressed then to transfer the results to the signals tab of the configuration.

5.2.4 Signals

All available objects, Object Instances, its corresponding Modbus register and other main parameters are listed in the signals tab. More information on each parameter and how to configure it can be found in the Intesis MAPS user manual for Modbus.

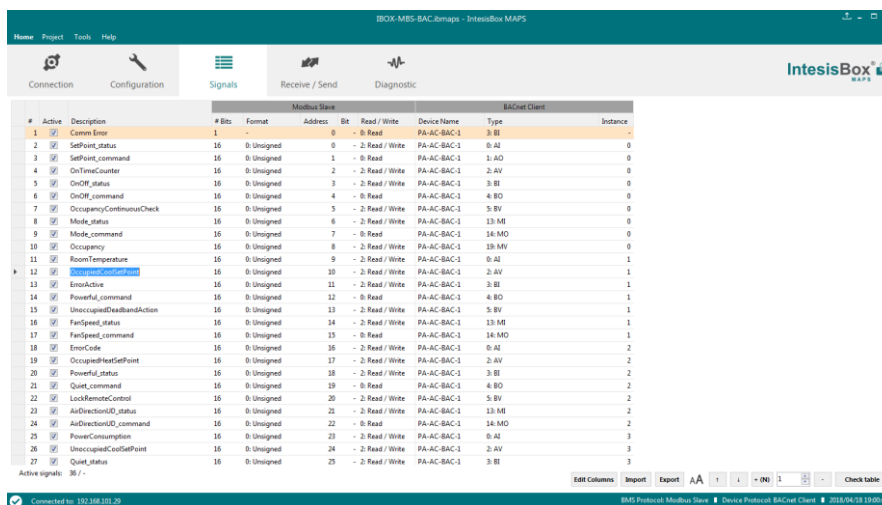

Figure 5.12 Intesis MAPS Signals tab

5.2.5 Sending the configuration to Intesis

When the configuration is finished, follow the next steps.

1.- Save the project (Menu option **Project->Save**) on your hard disk (more information in Intesis MAPS User Manual).

2.- Go to tab '**Receive / Send**' of MAPS, and in **Send** section, press **Send** button. Intesis will reboot automatically once the new configuration is loaded.

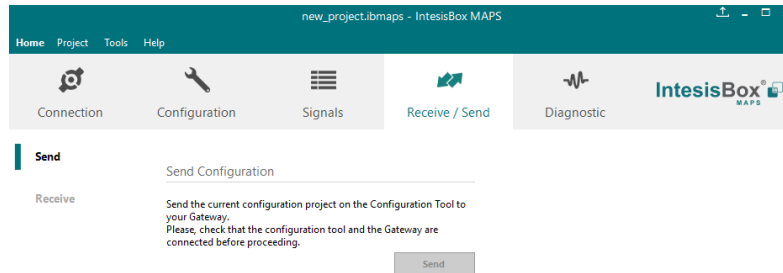

Figure 5.13 Intesis MAPS Receive/Send tab

After any configuration change, do not forget to send the configuration file to the Intesis using the Send button in the Receive / Send section.

5.2.6 Diagnostic

To help integrators in the commissioning tasks and troubleshooting, the Configuration Tool offers some specific tools and viewers.

In order to start using the diagnostic tools, connection with the Gateway is required.

The Diagnostic section is composed by two main parts: Tools and Viewers.

- **Tools**
Use the tools section to check the current hardware status of the box, log communications into compressed files to be sent to the support, change the Diagnostic panels' view or send commands to the gateway.
- **Viewers**
In order to check the current status, viewer for the Internal and External protocols are available. It is also available a generic Console viewer for general information about communications and the gateway status and finally a Signals Viewer to simulate the BMS behavior or to check the current values in the system.

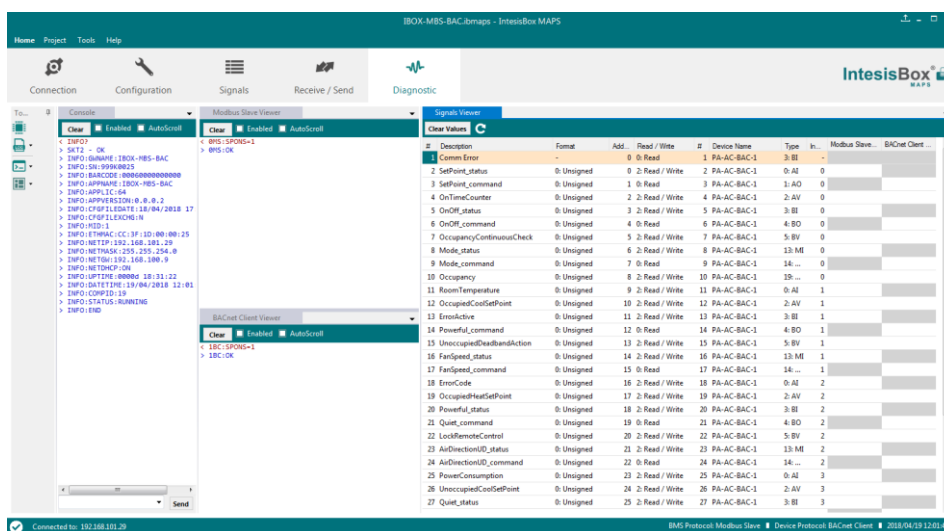

Figure 5.14 Diagnostic

More information about the Diagnostic section can be found in the Configuration Tool manual.

5.3 Set-up procedure

1. Install Intesis MAPS on your laptop, use the setup program supplied for this and follow the instructions given by the Installation wizard.
2. Install Intesis in the desired installation site. Installation can be on DIN rail or on a stable not vibrating surface (DIN rail mounted inside a metallic industrial cabinet connected to ground is recommended).
3. If using, Modbus RTU, connect the communication cable coming from the EIA485 port of the Modbus RTU installation to the port marked as Port B of Intesis (More details in section 2).

If using, Modbus TCP, connect the communication cable coming from the Ethernet port of the Modbus TCP installation to the port marked as Port B of Intesis (More details in section 2).

4. If using BACnet IP, connect the communication cable coming from the BACnet IP network to the port marked as Ethernet on Intesis (More details in section 2).

If using BACnet MSTP, connect the communication cables coming from the BACnet MSTP network to the port marked as Port A on Intesis (More details in section 2).

5. Power up Intesis. The supply voltage can be 9 to 30 Vdc or just 24 Vac. Take care of the polarity of the supply voltage applied.

WARNING! In order to avoid earth loops that can damage Intesis and/or any other equipment connected to it, we strongly recommend:

- The use of DC power supplies, floating or with the negative terminal connected to earth. **Never use a DC power supply with the positive terminal connected to earth.**
- The use of AC power supplies only if they are floating and not powering any other device.

6. If you want to connect using IP, connect the Ethernet cable from the laptop PC to the port marked as Ethernet of Intesis (More details in section 2).

If you want to connect using USB, connect the USB cable from the laptop PC to the port marked as Console of Intesis (More details in section 2).

7. Open Intesis MAPS, create a new project selecting a template for **INMBSBAC---0000**.
8. Modify the configuration as desired, save it and download the configuration file to Intesis as explained in the Intesis MAPS user manual.
9. Visit the Diagnostic section, enable COMMS and check that there is communication activity, some TX frames and some other RX frames. This means that the communication with the Centralized Controller and Modbus Master devices is OK. In case there is no communication activity between Intesis and the Centralized Controller and/or Modbus devices, check that those are operative: check the baud rate, the communication cable used to connect all devices and any other communication parameter.



Figure 5.15 Enable COMMS

6 Electrical & Mechanical Features



Enclosure	Plastic, type PC (UL 94 V-0) Net dimensions (d×w×h): 90x88x56 mm Recommended space for installation (d×w×h): 130x100x100mm Color: Light Grey. RAL 7035	Battery	Size: Coin 20mm x 3.2mm Capacity: 3V / 225mAh Type: Manganese Dioxide Lithium
Mounting	Wall. DIN rail EN60715 TH35.	Console Port	Mini Type-B USB 2.0 compliant 1500VDC isolation
Terminal Wiring (for power supply and low-voltage signals)	Per terminal: solid wires or stranded wires (twisted or with ferrule) 1 core: 0.5mm ² ... 2.5mm ² 2 cores: 0.5mm ² ... 1.5mm ² 3 cores: not permitted	USB port	Type-A USB 2.0 compliant Only for USB flash storage device (<i>USB pen drive</i>) Power consumption limited to 150mA (<i>HDD connection not allowed</i>)
Power	1 x Plug-in screw terminal block (3 poles) 9 to 36VDC +/-10%, Max.: 140mA. 24VAC +/-10% 50-60Hz, Max.: 127mA Recommended: 24VDC	Push Button	Button A: Will broadcast I-Am message in the BACnet network. Button B: Reserved for future use
Ethernet	1 x Ethernet 10/100 Mbps RJ45 2 x Ethernet LED: port link and activity	Operation Temperature	0°C to +60°C
Port A	1 x Serial EIA485 Plug-in screw terminal block (2 poles) A, B 1 x Plug-in screw terminal block green (2 poles) SGND (Reference ground or shield) 1500VDC isolation from others ports	Operational Humidity	5 to 95%, no condensation
Switch A (SWA)	1 x DIP-Switch for serial EIA485 configuration: Position 1: ON: 120 Ω termination active Off: 120 Ω termination inactive (default) Position 2-3: ON: Polarization active (default) Off: Polarization inactive	Protection	IP20 (IEC60529)
PORT B	1 x Serial EIA232 (SUB-D9 male connector) Pinout from a DTE device 1500VDC isolation from other ports (except PORT B: EIA485) 1 x Serial EIA485 Plug-in screw terminal block (3 poles) A, B, SGND (Reference ground or shield) 1500VDC isolation from other ports (except PORT B: EIA232)	LED Indicators	10 x On board LED indicators 1 x Error LED 1 x Power LED 2 x Ethernet Link/Speed 2 x Port A TX/RX 2 x Port B TX/RX 1 x Button A indicator 1 x Button B indicator
Switch B (SWB)	1 x DIP-Switch for serial EIA485 configuration: Position 1: ON: 120 Ω termination active Off: 120 Ω termination inactive (default) Position 2-3: ON: Polarization active Off: Polarization inactive (default)		

7 Dimensions

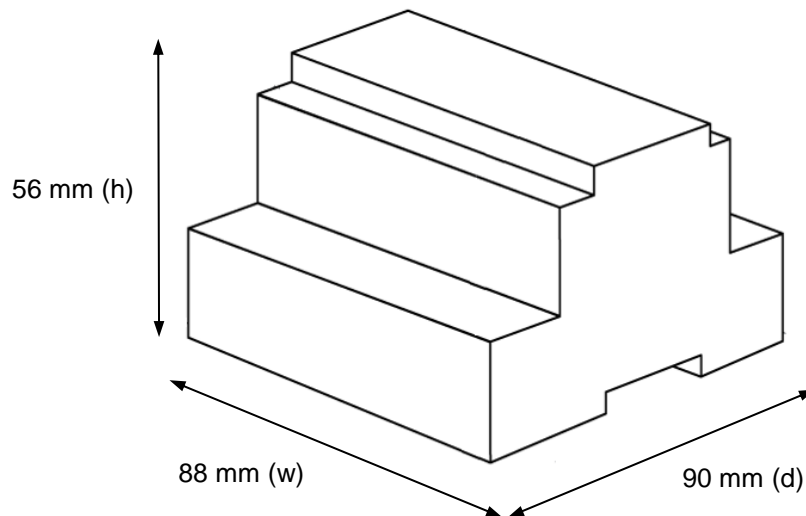

Recommended available space for its installation into a cabinet (wall or DIN rail mounting), with space enough for external connections

