

Modbus RTU (EIA-485) Interface for Mitsubishi Heavy Industries air conditioners

USER MANUAL

Issue date: 04/2019 r6.3 ENGLISH



Modbus RTU (EIA-485) Interface for Mitsubishi Heavy Industries air conditioners

ORDER CODE	LEGACY ORDER CODE
INMBSMHI001R000	MH-RC-MBS-1

Important User Information

Disclaimer

The information in this document is for informational purposes only. Please inform HMS Industrial Networks of any inaccuracies or omissions found in this document. HMS Industrial Networks disclaims any responsibility or liability for any errors that may appear in this document.

HMS Industrial Networks reserves the right to modify its products in line with its policy of continuous product development. The information in this document shall therefore not be construed as a commitment on the part of HMS Industrial Networks and is subject to change without notice. HMS Industrial Networks makes no commitment to update or keep current the information in this document.

The data, examples and illustrations found in this document are included for illustrative purposes and are only intended to help improve understanding of the functionality and handling of the product. In view of the wide range of possible applications of the product, and because of the many variables and requirements associated with any particular implementation, HMS Industrial Networks cannot assume responsibility or liability for actual use based on the data, examples or illustrations included in this document nor for any damages incurred during installation of the product. Those responsible for the use of the product must acquire sufficient knowledge in order to ensure that the product is used correctly in their specific application and that the application meets all performance and safety requirements including any applicable laws, regulations, codes and standards. Further, HMS Industrial Networks will under no circumstances assume liability or responsibility for any problems that may arise as a result from the use of undocumented features or functional side effects found outside the documented scope of the product. The effects caused by any direct or indirect use of such aspects of the product are undefined and may include e.g. compatibility issues and stability issues.

INDEX

- 1. Presentation 5
- 2. Connection 6
 - 2.1 Connect to the AC indoor unit 6
 - 2.2 Connection to the EIA-485 bus 7
- 3. Quick Start Guide..... 7
- 4. Modbus Interface Specification 8
 - 4.1 Modbus physical layer..... 8
 - 4.2 Modbus Registers..... 8
 - 4.2.1 Control and status registers 8
 - 4.2.2 Configuration Registers..... 11
 - 4.2.3 Considerations on Temperature Registers 12
 - 4.2.4 Special behavior – Center/Remote 14
 - 4.3 DIP-switch Configuration Interface 15
 - 4.4 Implemented Functions 18
 - 4.5 Device LED indicator 18
 - 4.6 EIA-485 bus. Termination resistors and Fail Safe Biasing mechanism 19
- 5. Mechanical and electrical features 20
- 6. List of supported AC Unit Types. 21
- 7. Error Codes 22

1. Presentation



The INMBSMHI001R000 interfaces allow a complete and natural integration of **Mitsubishi Heavy Industries** air conditioners into Modbus RTU (EIA-485) networks.

Reduced dimensions. 93 x 53 x 58 mm
3.7" x 2.1" x 2.3"

Quick and easy installation.
Mountable on DIN rail, wall, or even inside the indoor unit of AC.

- External power not required.
- Direct connection to Modbus RTU (EIA-485) networks. Up to 63 INMBSMHI001R000 devices can be connected in the same network.
INMBSMHI001R000 is a Modbus slave device.
- Direct connection to the AC indoor unit. Up to 16 AC indoor units can be connected to INMBSMHI001R000, controlling them as one (not individually).
- Configuration from both on-board DIP-switches and Modbus RTU.
- Total Control and Supervision.
- Real states of the AC unit's internal variables.
- Allows simultaneous use of the AC's remote controls and Modbus RTU.

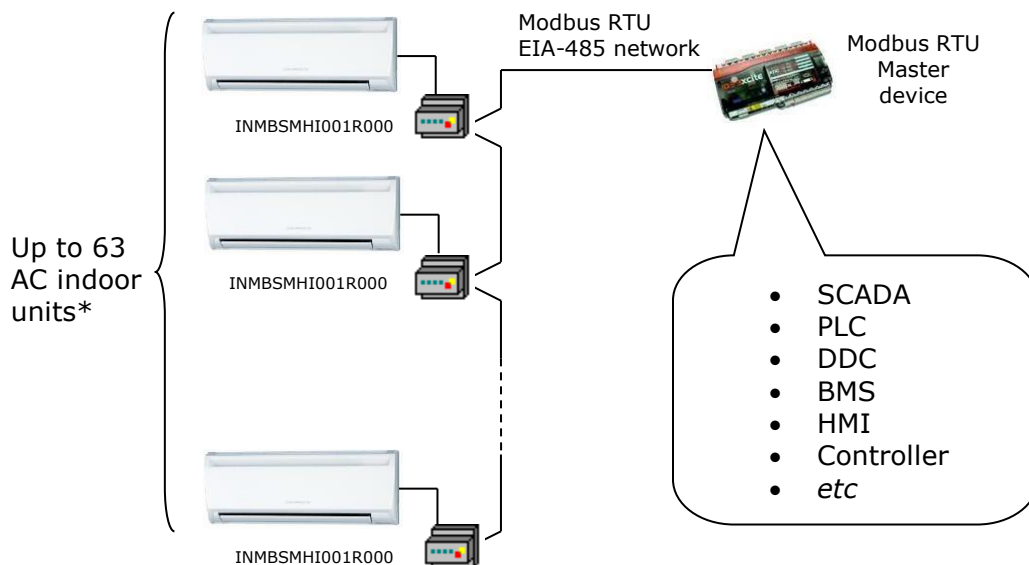

* Up to 63 Intesis devices can be installed in the same Modbus RTU bus. However, depending on the configured speed, the installation of Modbus Repeaters may be required

2. Connection

The interface comes with a plug-in terminal block of 2 poles to establish direct connection with the AC indoor unit. It comes as well with a plug-in terminal block of 2 poles to establish direct connection with the Modbus RTU EIA-485 network.

2.1 Connect to the AC indoor unit

The INMBSMHI001R000 connects directly to the Mitsubishi Heavy Industries XY Bus, which is not provided within the interface. Depending on which controllers are available, the recommended connection methods are the following ones (details in Figure 2. 1):

- **Wired remote controller available.** Connect the gateway as Slave in parallel with the wired remote controllers (Controller acts as Master).
- **No remote controller available** Connect the gateway directly to the XY bus of the indoor unit as Master when there is no Mitsubishi Heavy Industries Remote Controller.

Maximum XY bus length is 600 m / 1,968.5 ft. The bus has no polarity sensitivity.

Important: If a wired remote controller of the AC manufacturer is connected in the same bus, communication may shut down.

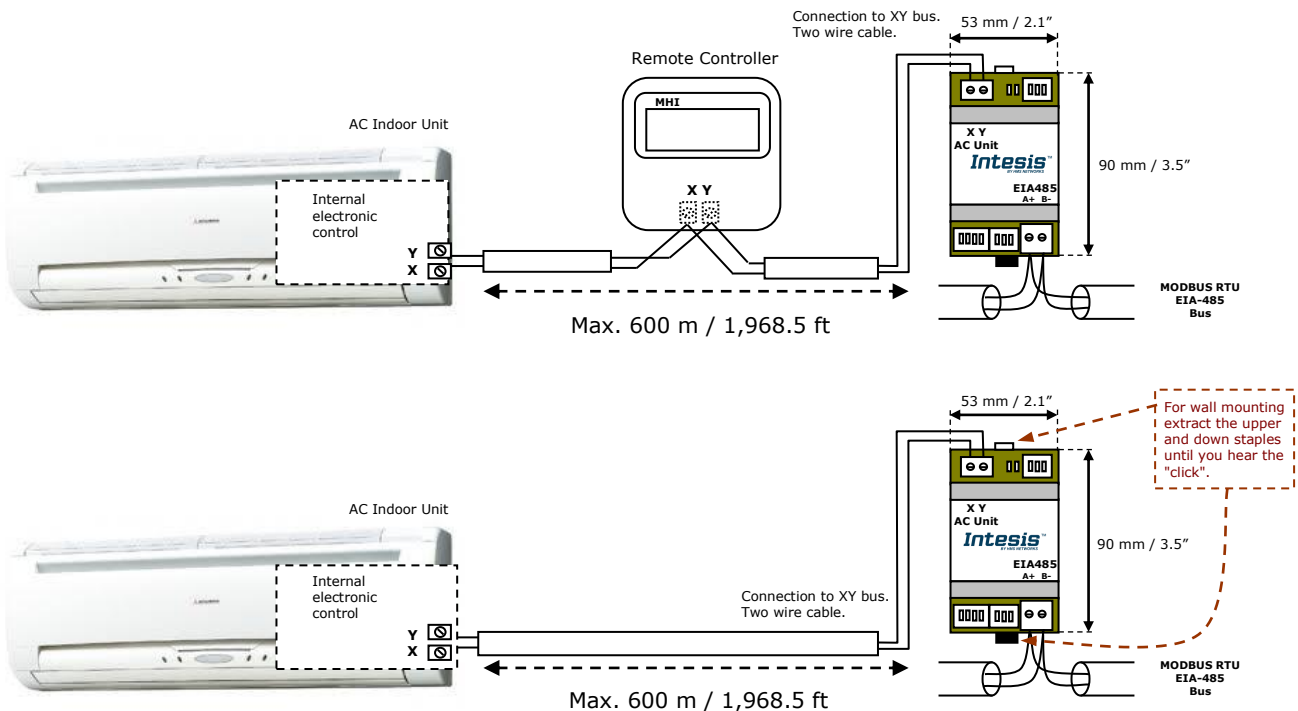

Figure 2. 1 INMBSMHI001R000 connection diagram

2.2 Connection to the EIA-485 bus

Connect the EIA-485 bus wires to the plug-in terminal block of INMBSMHI001R000 and keep the polarity on this connection (A+ and B-). Make sure that the maximum distance to the bus is 1,200 meters (3,937 ft). Loop or star typologies are not allowed in the case of the EIA-485 bus. A terminator resistor of 120Ω must be present at each end of the bus to avoid signal reflections. The bus needs a fail-safe biasing mechanism (see section 4.6 for more details).

3. Quick Start Guide

1. Disconnect the air conditioning from the Mains Power.
2. Attach the interface next to the AC indoor unit (wall mounting) following the instructions of the diagram below or install it inside the AC indoor unit (respect the safety instructions given).
3. Connect the XY bus between the interface and the AC indoor unit following the instructions of the diagram. Screw each bare cable end in the corresponding XY terminals of each device.
4. Connect the EIA-485 bus to the connector *EIA485* of the interface.
5. Close the AC indoor unit.
6. Check the DIP-Switch configuration of the Intesis interface and make sure it matches the current installation's parameters.

By default, the interface is set to:

- Modbus Slave Address → 1
- Modbus baud rate → 9600 bps



These parameters can be modified from SW4 and SW3 DIP-Switches.

All other switch positions are set at low level (Off position ) by default.

NOTE: All changes on the DIP-Switch configuration require a system power cycle to be applied.

7. Connect the AC system to Mains Power.

IMPORTANT: The Intesis interface requires to be connected to the AC unit (powered) to start communicating.

4. Modbus Interface Specification

4.1 Modbus physical layer

INMBSMHI001R000 implements a Modbus RTU (Slave) interface, to be connected to an EIA-485 line. It performs 8N2 communication (8 data bits, no parity and 2 stop bit) with several available baud rates (2400 bps, 4800 bps, 9600 bps -default-, 19200 bps, 38400 bps, 57600 bps, 76800 bps and 115200 bps). It also supports 8N1 communication (8 data bits, no parity and 1 stop bit).

4.2 Modbus Registers

All registers are type "16-bit unsigned Holding Register" and they use the *Modbus big endian* notation.

4.2.1 Control and status registers

Register Address (protocol address)	Register Address (PLC address)	R/W	Description																																		
0	1	R/W	AC unit On/Off <ul style="list-style-type: none"> ▪ 0: Off ▪ 1: On 																																		
1	2	R/W	AC unit Mode <ul style="list-style-type: none"> ▪ 0: Auto ▪ 1: Heat ▪ 2: Dry ▪ 3: Fan ▪ 4: Cool 																																		
2	3	R/W	AC unit Fan Speed ^{1,2} <table border="1" style="width: 100%; border-collapse: collapse;"> <thead> <tr> <th rowspan="2">Value</th> <th colspan="4">Num. of Fan Speeds</th> </tr> <tr> <th>4 (Default)</th> <th>3</th> <th>2</th> <th>1</th> </tr> </thead> <tbody> <tr> <td>0</td> <td colspan="4">Auto</td> </tr> <tr> <td>1</td> <td>Low</td> <td>Low</td> <td>Low</td> <td>High</td> </tr> <tr> <td>2</td> <td>Mid</td> <td>Mid</td> <td>High</td> <td>-</td> </tr> <tr> <td>3</td> <td>High</td> <td>High</td> <td>-</td> <td>-</td> </tr> <tr> <td>4</td> <td>Powerful</td> <td>-</td> <td>-</td> <td>-</td> </tr> </tbody> </table>	Value	Num. of Fan Speeds				4 (Default)	3	2	1	0	Auto				1	Low	Low	Low	High	2	Mid	Mid	High	-	3	High	High	-	-	4	Powerful	-	-	-
Value	Num. of Fan Speeds																																				
	4 (Default)	3	2	1																																	
0	Auto																																				
1	Low	Low	Low	High																																	
2	Mid	Mid	High	-																																	
3	High	High	-	-																																	
4	Powerful	-	-	-																																	
3	4	R/W	AC unit Vane Position ² <ul style="list-style-type: none"> ▪ 1: Position-1 ▪ 2: Position-2 ▪ 3: Position-3 ▪ 4: Position-4 ▪ 10: Swing 																																		

¹ Configuration following the Table 4.1 of this document

² Available values will depend on the AC unit mode. Check the AC unit model functions in its User Manual to know the possible values for this register.

Register Address (protocol address)	Register Address (PLC address)	R/W	Description
4	5	R/W	AC unit Temperature Setpoint ^{2,3,4} <ul style="list-style-type: none"> ▪ -32768 (Initialization value) ALL MODES (EXCEPT HEAT) <ul style="list-style-type: none"> ▪ 18..30°C (°C/x10°C) ▪ 64..86°F HEAT <ul style="list-style-type: none"> ▪ 16..30°C (°C/x10°C) ▪ 61..61°F
5	6	R	AC unit Temperature reference ^{2,3,4} <ul style="list-style-type: none"> ▪ -32768 (Initialization value) ▪ 10..38°C (°C/x10°C) ▪ 50..100°F
6	7	R/W	Window Contact <ul style="list-style-type: none"> ▪ 0: Closed (Default) ▪ 1: Open
7	8	R/W	INMBSMHI001R000 Disablement ⁵ <ul style="list-style-type: none"> ▪ 0: INMBSMHI001R000 enabled (Default) ▪ 1: INMBSMHI001R000 disabled
8	9	R/W	AC Remote Control Disablement ⁵ <ul style="list-style-type: none"> ▪ 0: Remote Control enabled (Default) ▪ 1: Remote Control disabled
9	10	R/W	AC unit Operation Time <ul style="list-style-type: none"> ▪ 0..65535 (hours). Counts the time the AC unit is in "On" state.
10	11	R	AC unit Alarm Status <ul style="list-style-type: none"> ▪ 0: No alarm condition ▪ 1: Alarm condition
11	12	R	Error Code ⁶ <ul style="list-style-type: none"> ▪ 0: No active error ▪ 65532 (-4): Initialization process (around 2min) before normal operation starts. This error appears in case that INMBSMHI001R000 is set as Master. ▪ 65535 (-1): Error in the communication of INMBSMHI001R000 or Remote Controller with the AC unit. ▪ Any other error present, see the table at the end of this document.
22	23	R/W	Indoor unit's ambient temperature from external sensor (at Modbus side) ^{2,3,4,7} <ul style="list-style-type: none"> ▪ -32768: (Initialization value). No temperature is being provided from an input sensor. There's no input sensor. ▪ Any other: (°C/x10°C/°F)

³ Magnitude for this register can be adjusted to Celsius x 1°C, Celsius x 10°C (default) or Fahrenheit. See section 4.2.3 for more information.

⁴ It is not possible turn to x10 the value shown in Fahrenheit.

⁵ This value is stored in non-volatile memory

⁶ See section 7 for possible error codes and their explanation

⁷ See section 4.2.3 for more information

Register Address (protocol address)	Register Address (PLC address)	R/W	Description
23	24	R	AC Real temperature setpoint ^{2,3,4,7} <ul style="list-style-type: none"> When the mechanism for "Virtual temperature" is not being applied, the value will be the one in the register 5 (PLC addressing). 16..31°C (°C/x10°C) 60..90°F
24	25	R	Current AC max setpoint ^{2,3,4} <ul style="list-style-type: none"> -32768 (Initialization value) Ranges are specific from Manufacturer
25	26	R	Current AC min setpoint ^{2,3,4} <ul style="list-style-type: none"> -32768 (Initialization value) Ranges are specific from Manufacturer
31	32	R	Status (feedback) <ul style="list-style-type: none"> 0: Not active (Default value) 1: Active (A window is open)
46	47	R	Center/Remote ⁸ <ul style="list-style-type: none"> 0: Remocon unlock (Center/Remote) 1: Remocon lock On/Off (Center) 2: Remocon lock All (Center) 3: Remocon Only (Remote)
55	56	R/W	Under voltage counter ⁵ <ul style="list-style-type: none"> 0..300(hours)
60	61	R	Outdoor Intake temperature ^{2,3,4} <ul style="list-style-type: none"> -32768d: (Initialization value) No temperature's value is being provided outdoor. No virtual temperature is applied. Any other: (°C/x10°C/°F)
65	66	R	Input reference temperature ^{2,3,4} <ul style="list-style-type: none"> -32768: (Initialization value). No temperature's value is being provided from an external sensor. No virtual temperature is applied. Any other: (°C/x10°C/°F)
66	67	R	Return Path temperature ^{2,3,4} <ul style="list-style-type: none"> -32768 (Initialization value) Any: (°C/x10°C/°F)
97	98	R/W	Block Periodic Sendings ^{5,9,10} <ul style="list-style-type: none"> 0: Non-blocked (Default value) 1: Blocked
98	99	R/W	Master/Slave (gateway) <ul style="list-style-type: none"> 0: Slave 1: Master

⁸ See section 4.2.4 for more information

⁹ If the register is configured as "0:Non-blocked", all commands received from Modbus will be sent to the AC system. If "1: Blocked", commands from Modbus will only be sent to the AC system if they differ from the previous value.

¹⁰ This register applies to firmware version 0.14 onwards

4.2.2 Configuration Registers

Register Address (protocol address)	Register Address (PLC address)	R/W	Description
13	14	R/W	"Open Window" switch-off timeout ¹¹ <ul style="list-style-type: none"> 0..30 (minutes) Factory setting: 30 (minutes)
14	15	R	Modbus RTU baud-rate <ul style="list-style-type: none"> 2400bps 4800bps 9600bps (Default) 19200bps 38400bps 57600bps 76800bps 115200bps
15	16	R	Modbus Slave Address <ul style="list-style-type: none"> 1..63
21	22	R	Max number of fan speeds
45	46	W	Error reset <ul style="list-style-type: none"> 1: Reset
48	49	R	Switch value
49	50	R	Device ID: 0x0F00
50	51	R	Software version
81	82	R	Error address <ul style="list-style-type: none"> Provides the indoor unit number which is providing error
99	100	W	Reset <ul style="list-style-type: none"> 1: Reset

While the initialization is ongoing, some Modbus registers will indicate an undetermined value. Once the normal operation starts, they will acquire its corresponding value. It is important to keep in mind that any change done during the initialization process will not have effect until it has been finished.

¹¹ Once window contact is open, a count-down to switch off the AC Unit will start from this configured value.

4.2.3 Considerations on Temperature Registers

- **AC unit temperature setpoint (R/W)**
(register 4 – in Protocol address / register 5 – in PLC address):
This is the adjustable temperature setpoint value that must be required by the user. This register can be read (Modbus function 3 or 4) or written (Modbus functions 6 or 16). A remote controller connected to the Mitsubishi Heavy Industries indoor unit will report the same temperature setpoint value as this register, but only will happen when no AC unit's external reference is provided from INMBSMHI001R000 (see detail for register 22/23 below).
- **AC unit temperature reference (R)**
(register 5 – in Protocol address / register 6 – in PLC address):
This register reports the temperature that is currently used by the Mitsubishi Heavy Industries indoor unit as the reference of its own control loop. Depending on the configuration of the indoor unit, this value can be the temperature reported by the sensor on the return path of the Mitsubishi Heavy Industries indoor unit or the sensor of its remote controller. It is a read-only register (Modbus functions 3 or 4).
- **AC unit external temperature reference (Modbus) (R/W)**
(register 22 – in Protocol address / register 23 – in PLC address):
This register allows us to provide an external temperature's sensor from the Modbus side. Mitsubishi Heavy Industries indoor unit does not allow on devices like INMBSMHI001R000 to provide directly temperature to be used as a reference of the control loop of the AC indoor unit. In order to overcome this limitation and enable the usage of an external temperature sensor (i.e. from Modbus side), INMBSMHI001R000 applies the following mechanism (only if "external temperature's reference" is being used):
 - After a couple of values have been entered in the "AC unit external temperature's reference" (register 22/23) and "AC unit temperature set point" (register 4/5), INMBSMHI001R000 is going to estimate the temperature chosen implied (e.g. if a "temperature setpoint (register 4/5)" of **22°C**, and an "external temperature reference (register 22/23)" of **20°C** are entered, INMBSMHI001R000 will assume that the user is demanding a **+2°C** increase in temperature).
 - By knowing at any time the ambient temperature currently used by the indoor unit to control its own operation (register 5/6), INMBSMHI001R000 can calculate the required temperature setpoint needed to apply the decrease/increase on the real temperature and reach the temperature chosen by the user (following the example above, if INMBSMHI001R000 reads an "ambient temperature" (register 5/6) of **24°C** in the indoor unit, it will apply a final setpoint of **24°C + 2°C = 26°C**).
 - At this moment, each time that INMBSMHI001R000 detects a change on the ambient temperature reported by the indoor unit (register 5/6), it will also change the required setpoint, in order to keep the temperature required by the user at any time. If we follow the last example, if INMBSMHI001R000 receives a new temperature's value coming from the indoor unit of **25°C**, INMBSMHI001R000 will automatically adjust the temperature setpoint required of the AC indoor unit to **25°C + 2°C = 27°C**).
 - In general, INMBSMHI001R000 is constantly applying the "Virtual Temperature" formula:

$$S_{AC} = S_u - (T_u - T_{AC})$$

Where:

- S_{AC} - setpoint value currently applied to the indoor unit
- S_u - setpoint value (register 4/5)
- T_u - external temperature reference written at Modbus side (register 22/23)
- T_{AC} - ambient temperature that the indoor unit is using as the reference of its own control loop (register 5/6)

When INMBSMHI001R000 detects a change in any of the values of $\{ S_u, T_u, T_{AC} \}$, it will send the new setpoint (S_{AC}) to the indoor unit.

- After the startup, the value for "external temperature's reference" (register 22/23) has a value -32768 (0x8000). This value means that no external temperature reference is being provided through INMBSMHI001R000. In this scenario, the AC indoor unit is going to use its own Return Path temperature from the sensor (register 66/67) as a reference of its own control loop. This process happens if the INMBSMHI001R000 has role as Master or as Slave.
 - When the mechanism of "Virtual Temperature" is applied, the temperature setpoint's value shown by the Remote Controller or other Control System from Mitsubishi Heavy Industries connected to the indoor unit may show a different value from the value shown in register 4/5.
 - If it is desired to use the temperature's reading from the Remote Control as the external temperature reference (T_u , register 22/33), the Remote Controller must be configured as Master, and the Mitsubishi Heavy Industries AC indoor unit must have the option "thermostat sensor in the Remote Controller" as activated. This configuration is done via a Mitsubishi Heavy Industries Remote Controller connected to the indoor unit and must be done by Mitsubishi Heavy Industries authorized installers while the AC is being installed.
 - When INMBSMHI001R000 is set as "Master" of XY bus, the external temperature's sensor connected to Modbus RTU EIA-485 network provides directly the value currently applied to the indoor unit (S_{AC}), and the process of the Virtual temperature is not applied. In this case, the Remote Controller or any other Control System connected from Mitsubishi Heavy Industries is not able to send the external temperature reference's value to the register 22/23.
- **AC Real temperature setpoint (R)**
(register 23 – In Protocol address / register 24 – in PLC address):
As it has been detailed on the previous point, the real temperature setpoint in the indoor unit and the temperature setpoint requested from INMBSMHI001R000 might differ (when a value in register 22/23 – "external temperature reference" is entered). This register always informs about the current temperature setpoint which is being used by the indoor unit – it also includes the temperature setpoint that will be shown by an additional remote controller from Mitsubishi Heavy Industries connected to the indoor unit, if it is present on the system.

Moreover, notice that temperature's values of all these four registers are expressed according to the temperature's format configured through its onboard DIP-Switches (See "4.3 - DIP-switch Configuration Interface"). These following formats are possible:

- **Celsius value:** Value in Modbus register is the temperature value in Celsius (i.e. a value "22" in the Modbus register must be interpreted as 22°C).
- **Decicelsius value:** Value in Modbus register is the temperature value in decicelsius (i.e. a value "220" in the Modbus register must be interpreted as 22.0°C).
- **Fahrenheit value:** Value in Modbus register is the temperature value in Fahrenheit (i.e. a value "72" in the Modbus register must be interpreted as 72°F (~22°C)).

4.2.4 Special behavior – Center/Remote

The Center/Remote register is a feature of the INMBSMHI001R000 related to the control, and it can be set to four different options:

- **0: Remote unlock** (Center/Remote). The indoor unit is being controlled by a BMS (Building Management System controlled across to Modbus RTU Master device) and it can be managed from the BMS, the Remote Controller or the INMBSMHI001R000.
- **1: Remote lock On/Off** (Center). The indoor unit is being controlled by a BMS (Building Management System controlled across to Modbus RTU Master device) and it can only be managed by the BMS. In this situation, the INMBSMHI001R000 is disabled for the On/Off function.
- **2: Remote lock All** (Center). The indoor unit is being controlled by a BMS (Building Management System controlled from Modbus RTU Master device) and it can only be managed by the BMS. In this case, the INMBSMHI001R000 keeps its status as disabled, like when the device disablement register (7/8) is set to 1.
- **3: Remote** (Remote). The indoor unit is not being controlled by any BMS (Building Management System controlled from Modbus RTU Master device). It can be managed from the Remote Controller or the INMBSMHI001R000.

For more information about this setting, please check your Mitsubishi Heavy Industries manual.

For firmware version 0.8 backwards (Check the register 50/51 of other firmware versions). The values could be as follows:

- **0: Remote unlock** (Center/Remote). The indoor unit is being controlled by a BMS (Building Management System controlled from Modbus RTU Master device) and it can be managed from the BMS, the Remote Controller or the INMBSMHI001R000.
- **1: Remote lock** (Center). The indoor unit is being controlled by a BMS (Modbus RTU Master device) and it can only be managed by the BMS (Building Management System controlled from Modbus RTU Master device). In this case, the INMBSMHI001R000 keeps its status as disabled, like when the device disablement register (7/8) is set to 1.
- **2: Remote** (Remote). The indoor unit is not being controlled by any BMS (Building Management System controlled from Modbus RTU Master device). It can be managed from the Remote Controller or the INMBSMHI001R000

4.3 DIP-switch Configuration Interface

All the configuration values on INMBSMHI001R000 can be written and read from Modbus interface. Otherwise, some of them can also be setup from its on-board DIP-switch interface. The device has DIP-switches SW1, SW3 and SW4 on the following locations:

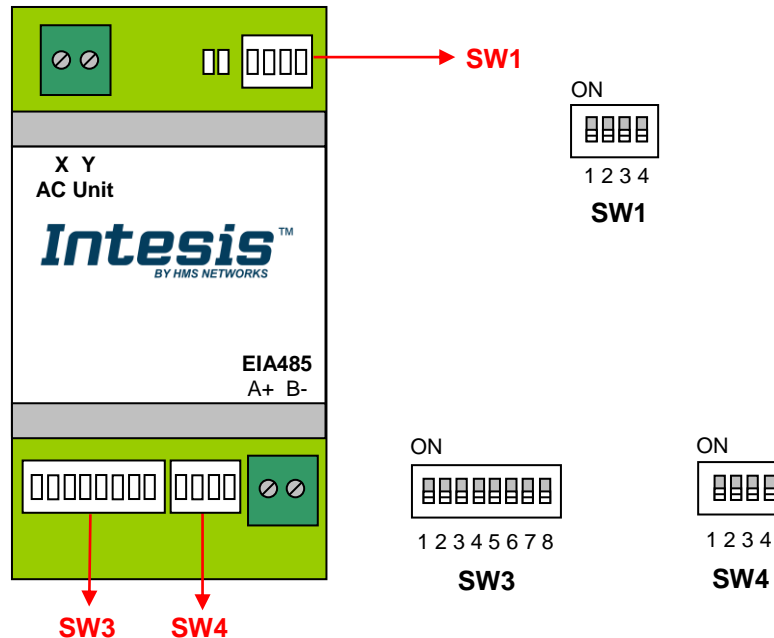

The following tables apply to the interface's configuration through DIP-switches:

SW1 – AC indoor unit's features

SW1-P1..4	Description
	Slave - A Mitsubishi Heavy Industries Controller must be present in XY bus, configured as Master (Default value)
	Master – Mitsubishi Heavy Industries Controller not needed in XY bus. If it exists, it must be configured as Slave
	Indoor unit has 1 Fan Speed
	Indoor unit has 2 Fan Speeds
	Indoor unit has 3 Fan Speeds
	Indoor unit has 4 Fan Speeds (Default value)
	Indoor unit has no Vanes
	Indoor unit has Vanes (Default Value)

Table 4.1 SW1: AC indoor unit's features

SW3/SW4 – Baud rate configuration















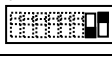

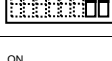
SW3-P7..8	SW4-P3	Description
		2400bps
		4800bps
		9600bps (Default value)
		19200bps
		38400bps
		57600bps
		76800bps
		115200bps

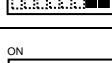
Table 4.2 SW3-SW4: Modbus baud rate

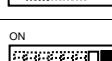
SW4 – Degrees/Decidegrees (x10), temperature magnitude (°C/°F) and EIA-485 termination resistor.

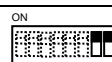





SW4-P1..2-4	Description
	Temperature values in Modbus register are represented in degrees (x1) (Default value)
	Temperature values in Modbus register are represented in decidegrees (x10)
	Temperature values in Modbus register are represented in Celsius degrees (Default value)
	Temperature values in Modbus register are represented in Fahrenheit degrees
	EIA-485 bus without termination resistor (Default value)
	Internal termination resistor of 120Ω connected to EIA-485 bus

Table 4.3 SW4: Temperature and termination resistor configuration

SW3 – Modbus Slave address

Add	SW3-P1..6	Add	SW3-P1..6	Add	SW3-P1..6	Add	SW3-P1..6	Add	SW3-P1..6
0		13		26		39		52	
1		14		27		40		53	
2		15		28		41		54	
3		16		29		42		55	
4		17		30		43		56	
5		18		31		44		57	
6		19		32		45		58	
7		20		33		46		59	
8		21		34		47		60	
9		22		35		48		61	
10		23		36		49		62	
11		24		37		50		63	
12		25		38		51			

Table 4.4 SW3: Modbus slave address

4.4 Implemented Functions

INMBSMHI001R000 implements the following standard Modbus functions:

- 3: Read Holding Registers
- 4: Read Input Registers
- 6: Write Single Register
- 16: Write Multiple Registers (Despite this function is allowed, the interface does not allow to write operations on more than 1 register with the same request, this means that length field should be always be 1 when this function is being used in case of writing)

4.5 Device LED indicator

The device includes two LED indicators to show all the possible operational states. In the following table there are written the indicators which can be performed and their meaning.

L1 (green LED)

Device status	LED indication	ON / OFF Period	Description
During not normal operation	LED blinking	500ms ON / 500ms OFF	Communication error
During normal operation	LED flashing	100ms ON / 1900ms OFF	Normal operation (configured and working properly)

L2 (red LED)

Device status	LED indication	ON / OFF Period	Description
During not normal operation	LED Pulse	3sec ON / --- OFF	Under voltage

L1 (green LED) & L2 (red LED)

Device status	LED indication	ON / OFF Period	Description
During normal operation	LED Pulse	5sec ON / --- OFF	Device Start-up
During not normal operation	LED alternatively blinking	500ms ON / 500ms OFF	Flash checksum not OK

4.6 EIA-485 bus. Termination resistors and Fail Safe Biasing mechanism

EIA-485 bus requires a 120Ω terminator resistor at each end of the bus to avoid signal reflections.

In order to prevent fail status detected by the receivers, which are "*listening*" the bus, when all the transmitters' outputs are in three-state (high impedance), it is also required a fail-safe biasing mechanism. This mechanism provides a safe status (a correct voltage level) in the bus when all the transmitters' outputs are in three-state. This mechanism must be supplied by the Modbus Master.

The INMBSMHI001R000 device includes an on-board terminator resistor of 120Ω that can be connected to the EIA-485 bus by using DIP-switch SW4.

Some Modbus RTU EIA-485 Master devices can provide also internal 120Ω terminator resistor and/or fail safe biasing mechanism (Check the technical documentation of the Master device connected to the EIA-485 network in each case).

5. Mechanical and electrical features

Enclosure	Plastic, type PC (UL 94 V-0) Net dimensions (dxwxh): 93 x 53 x 58 mm / 3.7" x 2.1" x 2.3" Color: Light Grey. RAL 7035	Operation Temperature	0°C to +60°C
Weight	85 g.	Stock Temperature	-20°C to +85°C
Mounting	Wall DIN rail EN60715 TH35.	Operational Humidity	<95% RH, non-condensing
Terminal Wiring (for low-voltage signals)	For terminal: solid wires or stranded wires (twisted or with ferrule) 1 core: 0.5mm ² ... 2.5mm ² 2 cores: 0.5mm ² ... 1.5mm ² 3 cores: not permitted	Stock Humidity	<95% RH, non-condensing
Modbus RTU port	1 x Serial EIA485 Plug-in screw terminal block (2 poles): A, B Compatible with Modbus RTU EIA-485 networks	Isolation voltage	1500 VDC
AC unit port	1 x XY bus Plug-in screw terminal block (2 poles): X, Y Compatible with Mitsubishi Heavy Industries networks	Isolation resistance	1000 MΩ
Switch 1 (SW1)	1 x DIP-Switch for AC features	Protection	IP20 (IEC60529)
Switch 3 (SW3)	1 x DIP-Switch for Modbus RTU settings	LED indicators	2 x Onboard LED - Operational status
Switch 4 (SW4)	1 x DIP-Switch for extra functions		

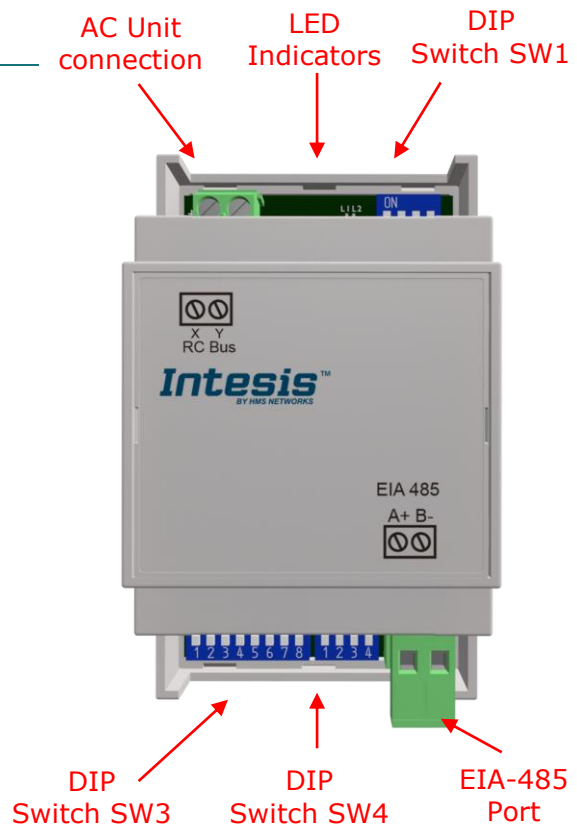
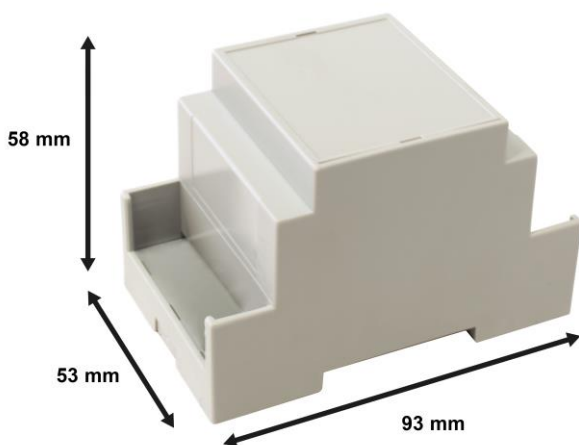

6. List of supported AC Unit Types.

A list of Mitsubishi Heavy Industries indoor unit model's references compatible with INMBSMHI001R000 and its available features can be found on this link:

https://www.intesis.com/docs/compatibilities/inxxmhi001rx00_compatibility

7. Error Codes

Error Code Modbus	Error in Remote Controller	Error Description
0	N/A	No active error
1	E1	Remote controller communication error
2	E2	Duplicated indoor unit address
3	E3	Outdoor unit signal line error
5	E5	Communication error during operation
6	E6	Indoor heat exchanger temperature thermistor anomaly
7	E7	Indoor return air temperature thermistor anomaly
8	E8	Heating overload operation
9	E9	Drain trouble
10	E10	Excessive number of indoor units (more than 17) by controlling one remote controller
12	E12	Address setting error by mixed setting method
14	E14	Communication error between master and slave indoor units
16	E16	Indoor fan motor anomaly
19	E19	Indoor unit operation check, drain motor check setting error
28	E28	Remote controller temperature thermistor anomaly
30	E30	Unmatched connection of indoor and outdoor unit
31	E31	Duplicated outdoor unit address No.
32	E32	Open L3 Phase on power supply at primary side
33	E33	Inverter primary current error
35	E35	Cooling overload operation
36	E36	Discharge pipe temperature error
37	E37	Outdoor heat exchanger temperature thermistor anomaly
38	E38	Outdoor/Ambient air temperature thermistor anomaly
39	E39	Discharge pipe temperature thermistor anomaly
40	E40	High pressure error
41	E41	Power transistor overheat
42	E42	Current cut
43	E43	Excessive number of indoor units connected, excessive total capacity of connection
45	E45	Communication error between inverter PCB and outdoor control PCB
46	E46	Mixed address setting methods coexistent in same network
47	E47	Inverter over-current error
48	E48	Outdoor DC fan motor anomaly
49	E49	Low pressure anomaly
51	E51	Inverter anomaly
53	E53	Suction pipe temperature thermistor anomaly
54	E54	High/Low pressure sensor anomaly
55	E55	Underneath temperature thermistor anomaly
56	E56	Power transistor temperature thermistor anomaly
57	E57	Insufficient in refrigerant amount or detection of service valve closure
58	E58	Anomalous compressor by loss of synchronism
59	E59	Compressor startup failure
60	E60	Rotor position detection failure / Anomalous compressor rotor lock
61	E61	Communication error between the master unit and slave units
63	E63	Emergency stop
65532 (-4)	N/A	Initialization process (around 2min) before normal operation starts. This error appears in case that INMBSMHI001R000 is set as Master.
65535 (-1)	N/A	Communication error of INMBSMHI001R000 or Remote controller with the AC unit.

In case to detect an error code not listed, contact your closest Mitsubishi Heavy Industries technical support service.